

Technische Daten

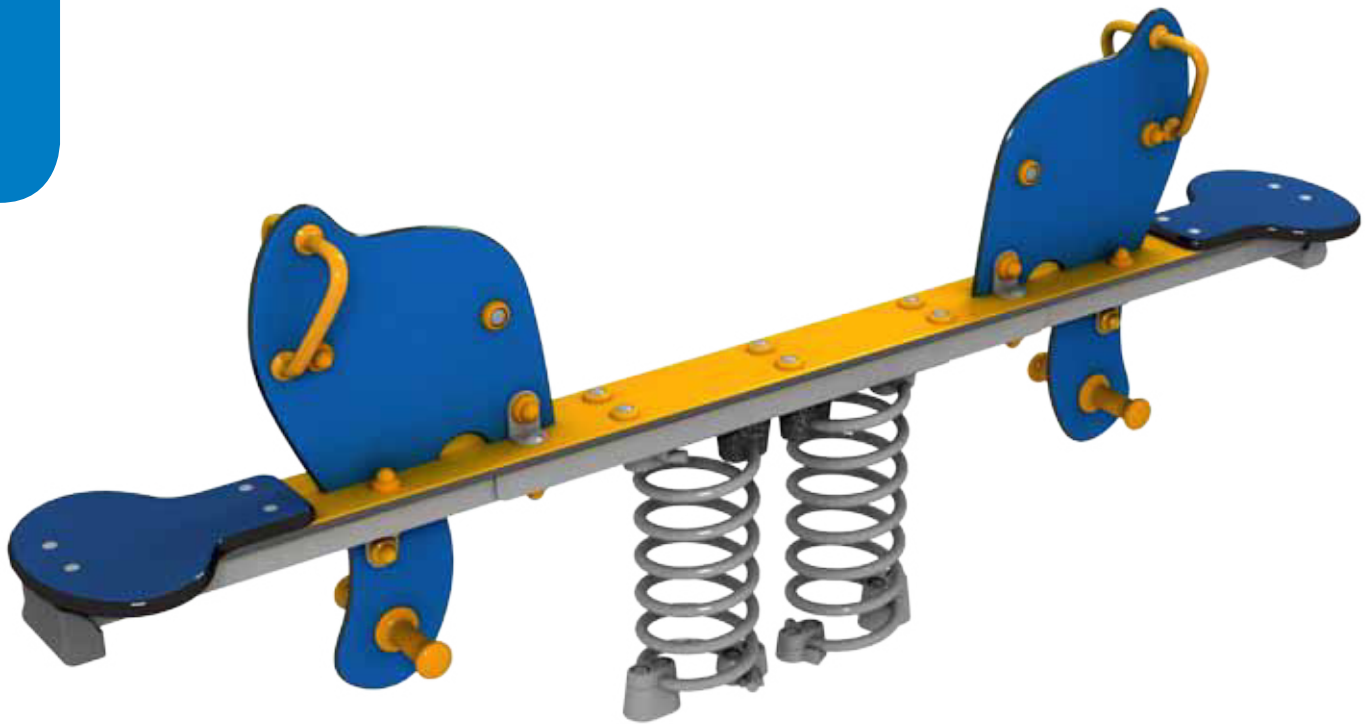

Platzbedarf

1: 100

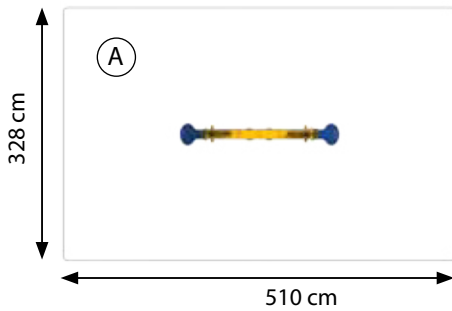

Maße

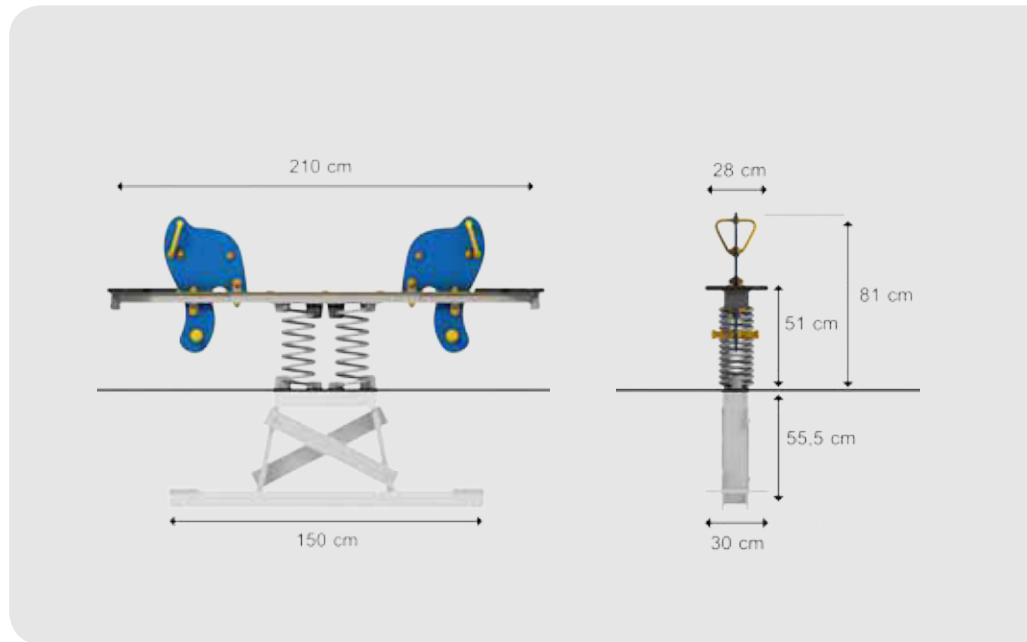

	HCL	m ²
(A)	81 cm	16,73 m ²

